

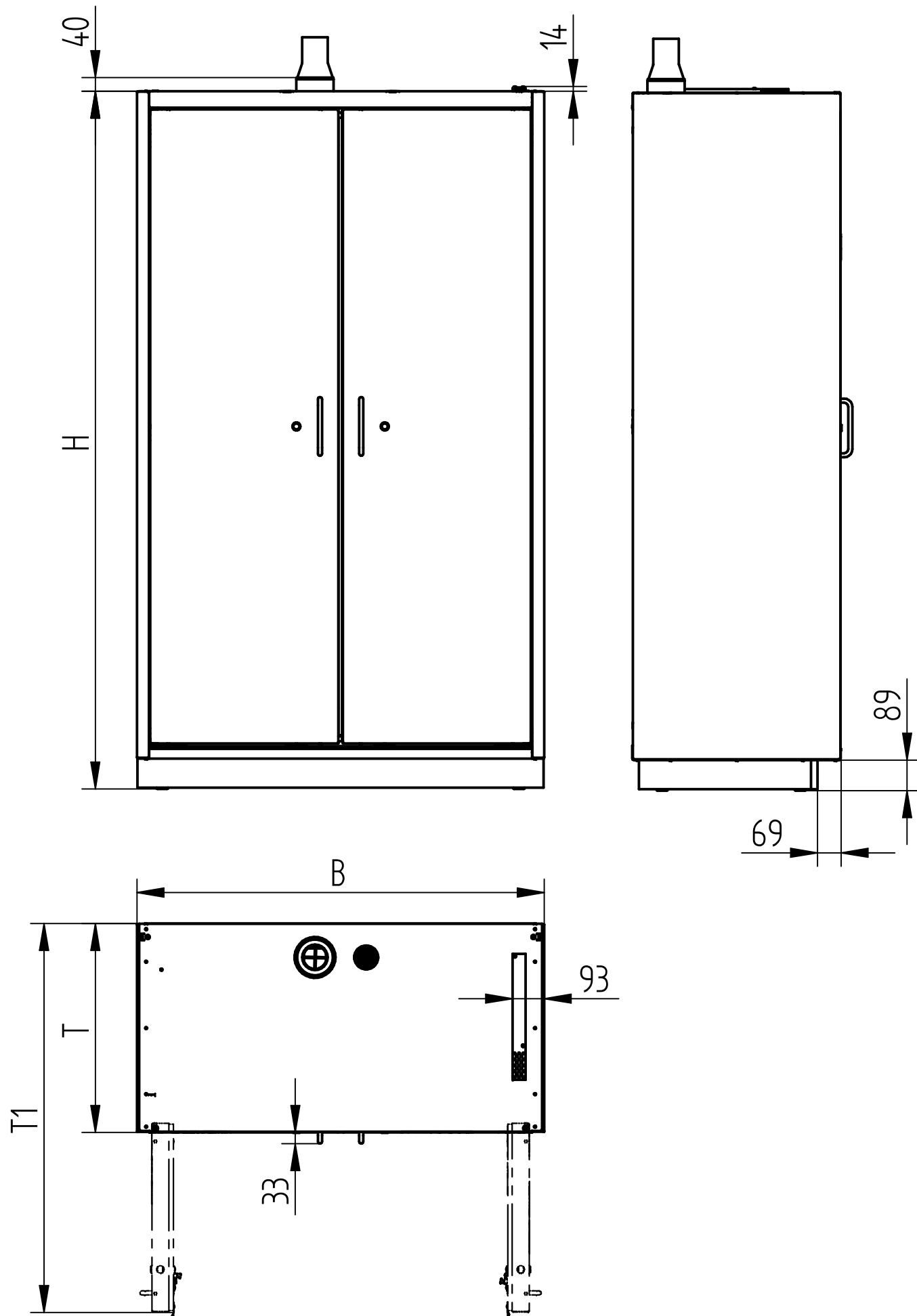

|   | Model type |      |      |      |      |      |      |      |          |         |
|---|------------|------|------|------|------|------|------|------|----------|---------|
|   | S          | SL   | XS   | M    | ML   | L    | LL   | XL   | XL (CPW) | XXL     |
| H (mm)                                  | 1385       | 1385 | 1385 | 2045 | 2045 | 2045 | 2045 | 2045 | 2045     | 2045    |
| B (mm)                                  | 594        | 594  | 1194 | 594  | 594  | 894  | 894  | 1194 | 1194     | 1654    |
| T (mm)                                  | 612        | 747  | 612  | 612  | 747  | 612  | 747  | 612  | 612      | 747     |
| T1 (mm)                                 | 1100       | 1235 | 1140 | 1100 | 1235 | 990  | 1123 | 1140 | 1140     | 1483    |
| Doors                                   | 1          | 1    | 2    | 1    | 1    | 2    | 2    | 2    | 2        | 2       |
| Tare weight (kg)                        | 200        | 230  | 335  | 275  | 320  | 370  | 415  | 455  | 485      | 850     |
| Inside cabinet volume (m <sup>3</sup> ) | 0,28       | 0,36 | 0,61 | 0,43 | 0,55 | 0,69 | 0,89 | 0,95 | 0,95     | 2x 0,83 |

CPW: Centre partition wall

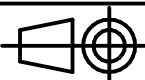

### Outer dimensions

|   |  |                  |   |
|---|--|------------------|---|
| This drawing is our property!<br>Furnish this information to other persons and reproduce or copy is not permitted without our written permission. | title: CLASSIC standard<br>Type 90, safety cabinet with wing door(s) |                  |  |
|   | drawing no.: 000104769   | page: 1 of 4     |   |
| Düperthal Sicherheitstechnik<br>Frankenstrasse 3<br>D-63791 Karlstein   | revision: 01   | date: 2020-03-05 |  |

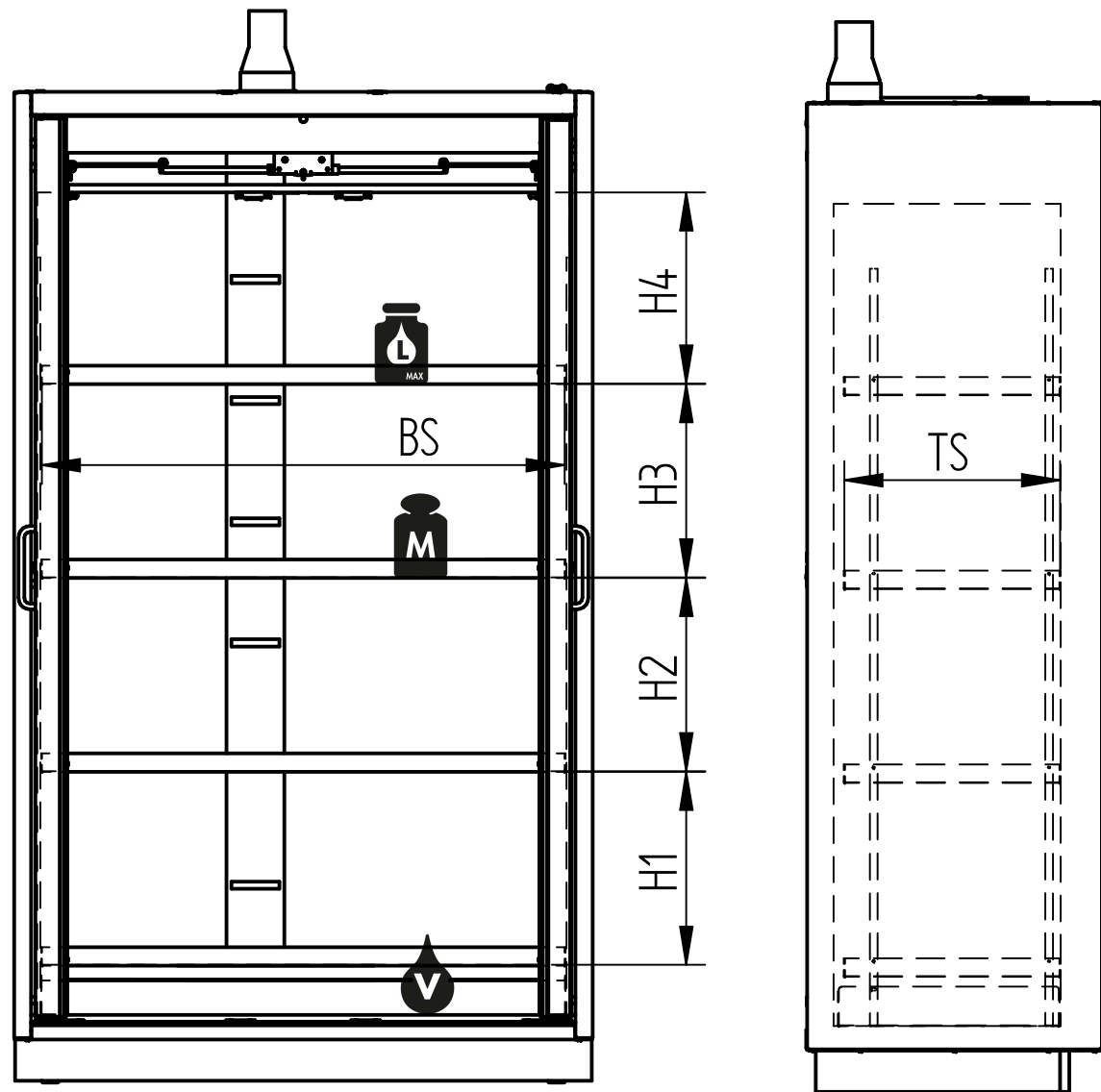



|                                  | Model type |      |      |     |      |     |      |      |          |        |
|----------------------------------|------------|------|------|-----|------|-----|------|------|----------|--------|
|                                  | S          | SL   | XS   | M   | ML   | L   | LL   | XL   | XL (CPW) | XXL    |
| <b>BS (mm)</b>                   | 481        | 481  | 1081 | 481 | 481  | 781 | 781  | 1081 | 2x 524   | 2x 729 |
| <b>TS (mm)</b>                   | 444        | 579  | 444  | 444 | 579  | 444 | 579  | 444  | 444      | 579    |
| <b>M (kg)</b>                    | 75         | 75   | 75   | 75  | 75   | 75  | 75   | 75   | 75       | 75     |
| <b>Max. additional load (kg)</b> | 240        | 240  | 240  | 360 | 360  | 360 | 360  | 360  | 360      | 2x 360 |
| <b>L (l)</b>                     | 10         | 15   | 30   | 10  | 15   | 20  | 25   | 30   | 15       | 25     |
| <b>V (l)</b>                     | 11         | 16,5 | 33   | 11  | 16,5 | 22  | 27,5 | 33   | 16,5     | 27,5   |
| <b>Number of storage shelves</b> | 2          | 2    | 2    | 4   | 4    | 4   | 4    | 4    | 8        | 8      |

- BS: Width storage shelf
- TS: Depth storage shelf
- M: Load bearing capacity per storage shelf (uniformly distributed)
- L: Max. volume of the individual container
- V: Max. collection volume
- CPW: Centre partition wall

| Max. setting heights (mm) |    |            |                       |
|---------------------------|----|------------|-----------------------|
|                           |    | Model type |                       |
|                           |    | S, SL, XS  | M, ML, L, LL, XL, XXL |
| Storage shelves           | H1 | 478        | 398                   |
|                           | H2 | ---        | 398                   |
|                           | H3 | ---        | 398                   |
|                           | H4 | 454        | 394                   |

**Storage shelves adjustable in 16mm pitch**

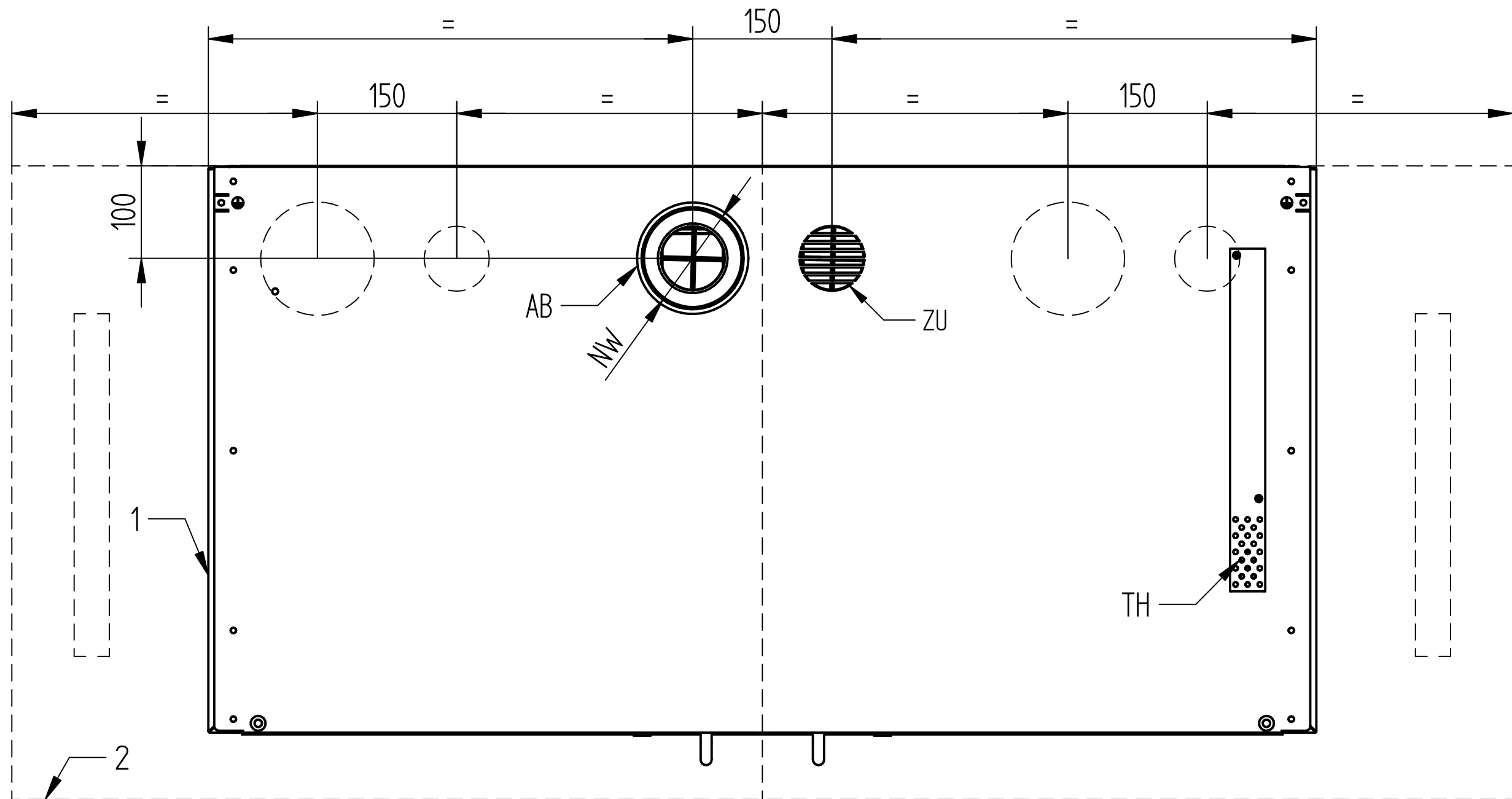

#### Inner dimensions

|   |  |                  |   |
|---|--|------------------|---|
| This drawing is our property!<br>Furnish this information to other persons and reproduce or copy is not permitted without our written permission. | title: CLASSIC standard<br>Type 90, safety cabinet with wing door(s) |                  |  |
|   | drawing no: 000104769  | page: 2 of 4     |   |
| Düperthal Sicherheitstechnik<br>Frankenstrasse 3<br>D-63791 Karlstein   | revision: 01   | date: 2020-03-05 |  |



- 1: Model type S-XL
- 2: Model type XXL
- NW: 110, with adapter 75
- AB: Exhaust air connection
- ZU: Supply air
- TH: Thermocouple

### Ventilation connection

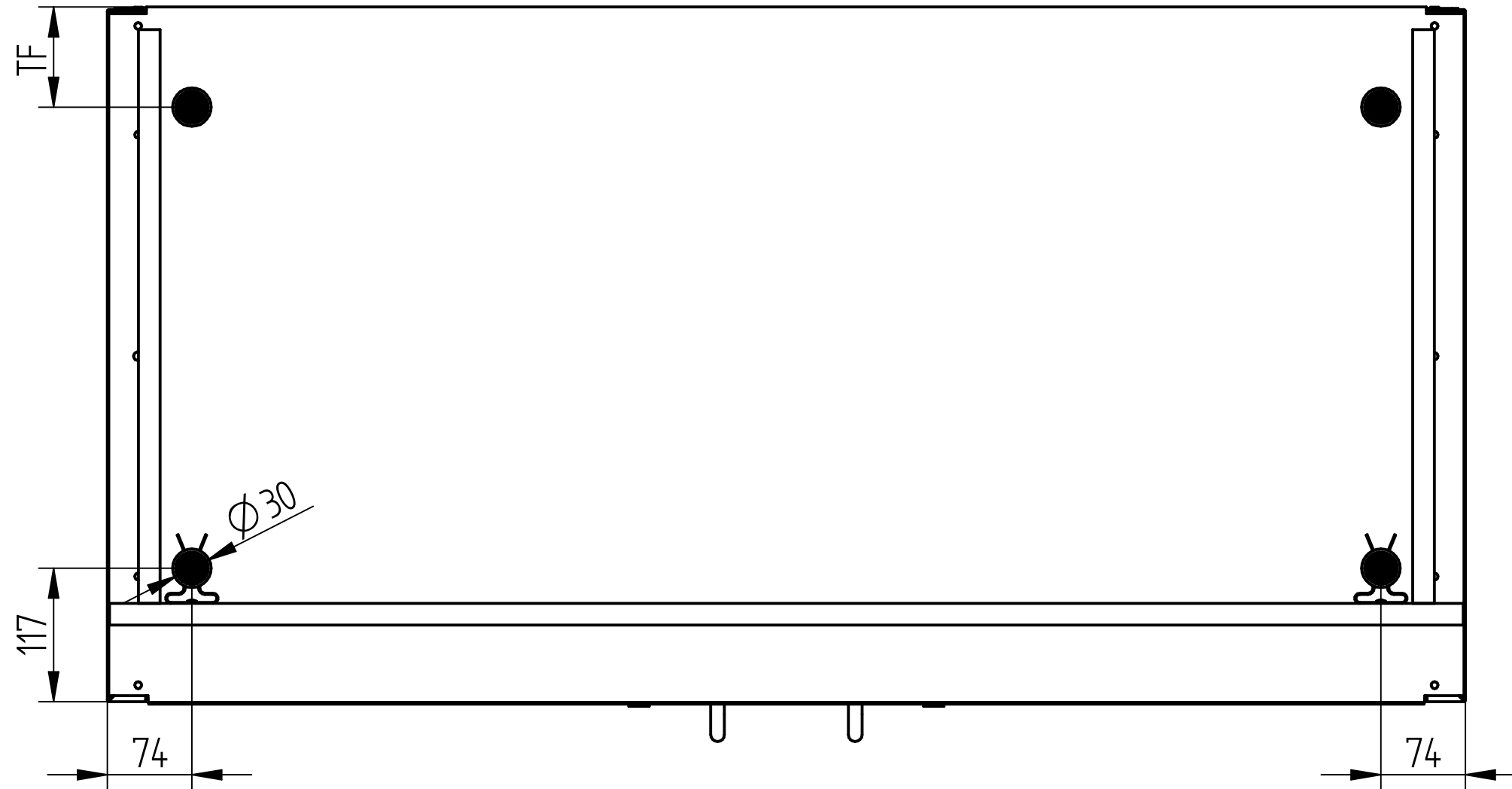

|  |  |   |   |
|--|--|---|---|
| This drawing is our property!<br>Furnish this information to other<br>persons and reproduce or copy is<br>not permitted without our<br>written permission. | title: CLASSIC standard<br>Type 90, safety cabinet with wing door(s) |   |  |
|  | drawing no: 000104769  | page: 3 of 4  |   |
| Düperthal Sicherheitstechnik<br>Frankenstrasse 3<br>D-63791 Karlstein  |  |  |   |

|         | Model type   |                          |
|---------|--------------|--------------------------|
|         | SL,ML,LL,XXL | S, XS, M, L, XL, XL(CPW) |
| TF (mm) | 83           | 88                       |



● Loaded footprint

### Geometry of the adjustable feet

|   |  |                  |   |
|---|--|------------------|---|
| This drawing is our property!<br>Furnish this information to other persons and reproduce or copy is not permitted without our written permission. | title: CLASSIC standard<br>Type 90, safety cabinet with wing door(s) |                  |  |
|   | drawing no: 000104769  | page: 4 of 4     |   |
| Düperthal Sicherheitstechnik<br>Frankenstrasse 3<br>D-63791 Karlstein   | revision: 01   | date: 2020-03-05 |  |